

The VTB EN54 Part 3 & 23 Approved sounder beacon is part of the VTG/VTB family of products designed for use with conventional fire alarm systems

The sounder function like all VTG family of products comes as standard with 32 tones.

The VAD beacon has been approved to EN54-23, at C-3-8 coverage range (Reduced room size coverage available via the DIL switch C-3-4, but does not comply with EN54-23)

The sounder function features a two-stage alarm override which is activated by a third negative wire from the fire panel.

Both the sounder and beacon functions are fully synchronised. The sounder function has been fully approved to EN54 Part 3 by Intertek on tones 1, 8, 11, 25 and 27. The product can also be used as a beacon only which is easily selected by a DIL switch at the time of installation.

Approved at 1Hz flash rate.(0.5Hz flash rate Available via the DIL switch, but does not comply with EN54-23)

- Sounder function fully approved to EN54-3 and beacon (VAD) to EN54-23
- 32 tones plus a selectable override tone
- Shallow base IP21C and deep base IP33C versions available
- Designed to work with conventional alarm circuits
- Switch selectable beacon only feature
- Unique twist and lock bayonet mounting system
- Removable cover on deep base for surface wiring
- Features base locking system as standard



## TECHNICAL

Voltage Range (VDC)	18 - 30	
Number of Tones	32	
Operating Frequency (Hz)	440 - 2900	
Temperature Range (°C)	-20 to +70	
Flash Rate	c.1Hz (Approved) (Option for 0.5Hz does not comply with EN54-23)	
Monitoring	Reverse Polarity	
Protection Rating (EN54 Approved)	IP21C (Shallow)	IP33C (Deep)
Protection Rating (BS EN 60529)	IP65C(Deep)	
Base Part Numbers	Shallow 116-085 Red 116-086 White	Deep 126-021 Red 126-022 White
Boxed weight (kg)	0.22 (Shallow)	0.25 (Deep)
Body colours available	Red or White (ABS fire retardant plastic)	
Lens colours available/flash colour	Red lens / White flash	

## ORDERING INFORMATION

VTB-32EVAD EN54-3 & 23 Red body, 32 tone, shallow base, white flash	511-207
VTB-32EVAD EN54-3 & 23 Red body, 32 tone, deep base, white flash	511-208
VTB-32EVAD EN54-3 & 23 White body, 32 tone, shallow base, white flash	511-201
VTB-32EVAD EN54-3 & 23 White body, 32 tone, deep base, white flash	511-202

## PERFORMANCE

Volume setting	High	Low
Tone 1 sound output, (dBA)	98	66
Max. current consumption @ 24Vdc (mA)	40	25
Max power consumption @ 24Vdc (mW)	960	600
Beacon coverage	C-3-8 (Approved) (option for C-3-4 does not comply with EN54-23)	
Coverage volume:	151m <sup>3</sup>	
Light temporal pattern	Single pulse width of 35 - 100ms @ frequency of 1Hz (approved at 100ms)	

Maintenance: refer to local test and maintenance guidance

## APPROVALS INFORMATION

**EN54-3**
**EN54-23**

 15  
 0905-CPR-00473

innovationdesignmanufacture

**DIMENSIONS**

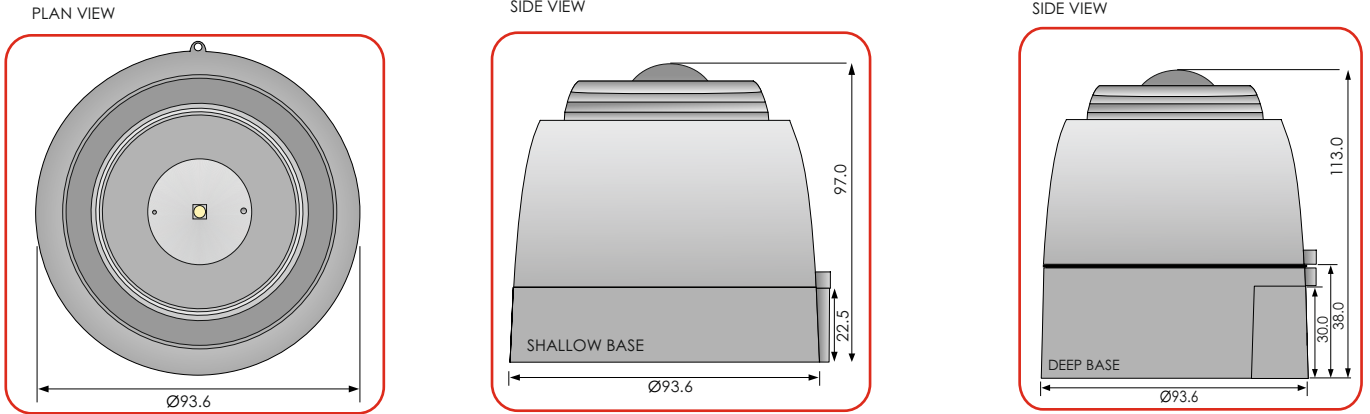

**PRODUCT MOUNTING & CABLE ENTRY**

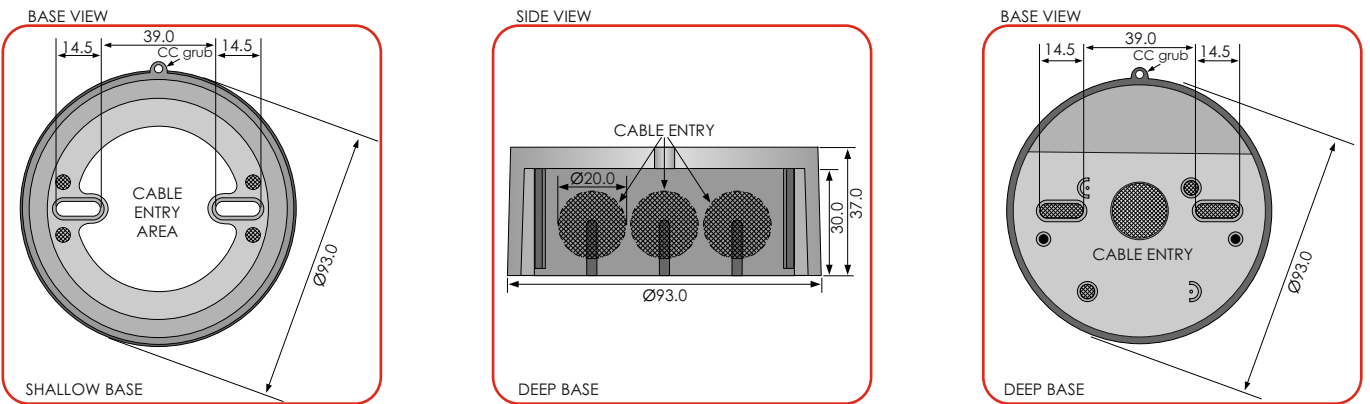

**WIRING CONFIGURATION**

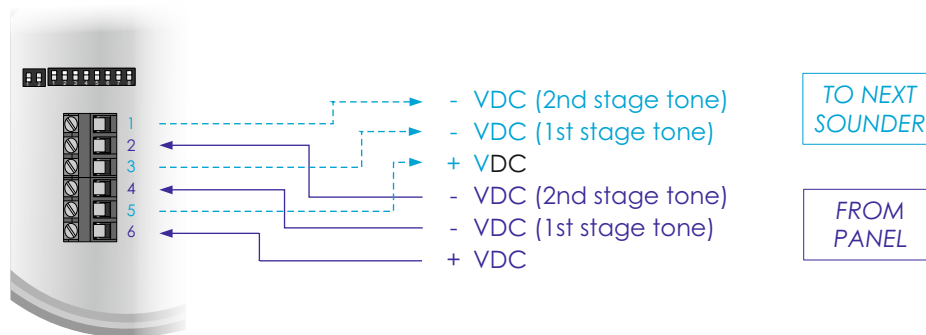

**TONE & VOLUME SELECTION**

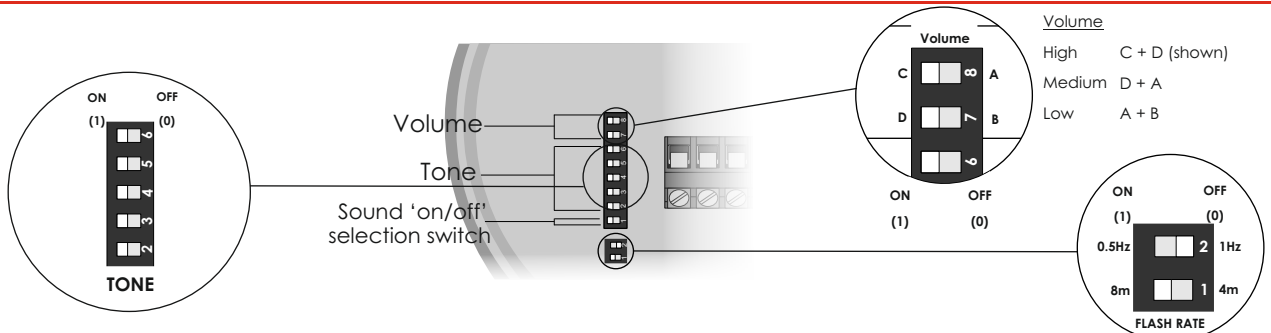

**TONE LIST - GRAPHICAL**
**Tones 1,8,11(Second Stage Tone),25 & 27 Approved to EN54-3**

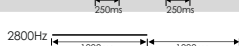
Switch (23456)	Nc.	Name	1st Stage Frequency	1st Stage Graphical	2nd Stage Frequency	2nd Stage Graphical
11111	1	<b>LF Sweep (Cranford sweep)</b>	<b>800-1000Hz swept every 500ms (2Hz)</b>		800Hz continuous	
11110	2	Alternative warble BS	800Hz for 250ms, then 960Hz for 250ms		800Hz continuous	
11101	3	Warble Tone BS	800Hz for 500ms, then 1000Hz for 500ms		800Hz continuous	
11100	4	Alternative warble BS	500Hz for 250ms, then 600Hz for 250ms		500Hz continuous	
11011	5	HF Back up Interrupted	2800Hz for 1000ms, then off for 1000ms		2800Hz continuous	
11010	6	LF Back up Alarm	800Hz for 150ms, then off for 150ms		800Hz continuous	
11001	7	HF Back up Interrupted	2800Hz for 150ms, then off for 150ms		800Hz continuous	
11000	8	<b>LF Continuous tone BS5839</b>	<b>800Hz continuous</b>		800Hz continuous	
10111	9	Sweep - 1Hz	800-900Hz swept every 1000ms (1Hz)		800Hz continuous	
10110	10	Australian slow whoop	970Hz for 625ms, then off for 150ms		500-1200Hz for 3500ms, then off for 250ms	
10101	11	<b>Dutch sweep</b>	970Hz continuous		<b>500-1200Hz for 3500ms, then off for 500ms</b>	
10100	12	Analogue sweep	500-600Hz swept every 500ms (2Hz)		500Hz continuous	
10011	13	Sweep - 3Hz	800-970Hz swept every 333ms (3Hz)		800Hz continuous	
10010	14	Alternate HF slow sweep	2350-2900Hz swept every 333ms (3Hz)		2400Hz continuous	
10001	15	Fast HF sweep	2400-2800Hz swept every 143ms (7Hz)		2400Hz continuous	
10000	16	US Temporal Pattern LF	950Hz for 500ms on, 500ms off (x3), then 1500ms off		800Hz continuous	
01111	17	Interrupted BS	800Hz for 500ms, then off for 500ms		800Hz continuous	
01110	18	ISO 8201 LF BS5839 Pt 1	970Hz for 500ms, then off for 500ms		970Hz for 500ms, then off for 500ms	
01101	19	Interrupted medium	1000Hz for 250ms, then off for 250ms		800Hz continuous	
01100	20	ISO8201 HF	2850Hz for 500ms, then off for 500ms		2850Hz for 500ms, then off for 500ms	
01011	21	Continuous	1000Hz continuous		1000Hz continuous	
01010	22	LF Buzz	800-950Hz swept every 9ms (110Hz)		800Hz continuous	
01001	23	HF Continuous	2800Hz continuous		2800Hz continuous	
01000	24	Sweep	800-970Hz swept every 111ms (9Hz)		800Hz continuous	
00111	25	<b>German DIN tone</b>	<b>1200-500Hz swept every 1000ms (1Hz)</b>		800Hz continuous	
00110	26	Swedish Fire signal	660Hz for 150ms, then off for 150ms		660Hz for 150ms, then off for 150ms	
00101	27	<b>French tone AFNOR</b>	<b>554Hz for 100ms, then 440Hz for 400ms</b>		800Hz continuous	
00100	28	Swedish all clear signal	660Hz continuous		660Hz continuous	
00011	29	US Temporal Pattern HF	2900Hz for 500ms on, 500ms off (x3), then 1500ms off		2900Hz continuous	
00010	30	Siren 2 way ramp (short)	500-1200Hz rising for 250ms, then falling for 250ms		800Hz continuous	
00001	31	FP1063.1-Telecom	800Hz for 250ms, then 970Hz for 250ms		800Hz continuous	
00000	32	Siren 2 way ramp (long)	500-1200Hz rising for 3000ms, then falling for 3000ms		800Hz continuous	

**EN54-3 APPROVED MINIMUM SOUND OUTPUT AT 1 METRE - LOW VOLUME**
**Tone 1 - Cranford Sweep Tone**

Angle	Horizontal Plane dB(A)		Vertical Plane dB(A)	
	Vmin	Vmax	Vmin	Vmax
15°	67.23	72.31	66.307	71.94
45°	67	72.24	66.02	71.84
75°	75.06	80.21	74.84	79.99
105°	75.45	80.56	75.034	80.29
135°	66.46	72.13	67.44	72.43
165°	67.53	73.09	68.402	73.04

**Tone 8 - 800Hz Continuous Tone**

Angle	Horizontal Plane dB(A)		Vertical Plane dB(A)	
	Vmin	Vmax	Vmin	Vmax
15°	65.27	70.44	65.375	70.778
45°	65.08	70.45	64.753	70.193
75°	74.81	79.86	74.628	79.837
105°	75.06	80.2	75.377	80.53
135°	66.24	71.3	66.919	72.14
165°	65.99	71.13	66.34	71.732

**Tone 11 - Dutch Sweep Tone**

Angle	Horizontal Plane dB(A)		Vertical Plane dB(A)	
	Vmin	Vmax	Vmin	Vmax
15°	64.79	70.38	64.189	69.689
45°	67.05	72.6	66.63	72.164
75°	72.56	78.13	72.293	78.226
105°	72.36	77.94	72.236	77.918
135°	67.4	72.84	67.588	72.567
165°	64.04	69.4	64.683	69.633

**Tone 25 - German DIN Tone**

Angle	Horizontal Plane dB(A)		Vertical Plane dB(A)	
	Vmin	Vmax	Vmin	Vmax
15°	65.84	70.76	66.096	71.373
45°	66.62	71.44	66.808	72.435
75°	74.9	80.1	74.909	80.188
105°	75.16	80.35	75.108	80.296
135°	68.04	73.91	66.672	71.455
165°	67.21	72.75	66.078	71.123

**Tone 27 - French AFNOR Tone**

Angle	Horizontal Plane dB(A)		Vertical Plane dB(A)	
	Vmin	Vmax	Vmin	Vmax
15°	64.851	70.152	65.446	70.574
45°	65.384	70.652	66.345	71.659
75°	74.374	79.568	74.287	79.466
105°	74.815	80.044	74.74	79.885
135°	66.633	71.953	65.512	70.79
165°	65.633	71.856	65.586	70.809

**Tone 1- Cranford Sweep Tone**

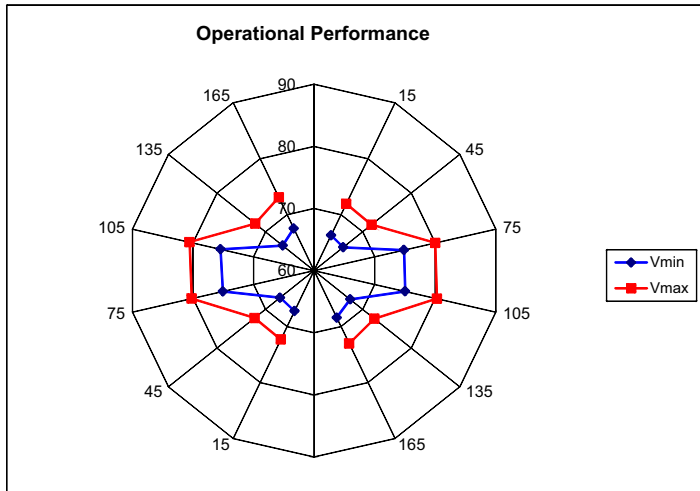

**Tone 8 - 800Hz Continuous Tone**

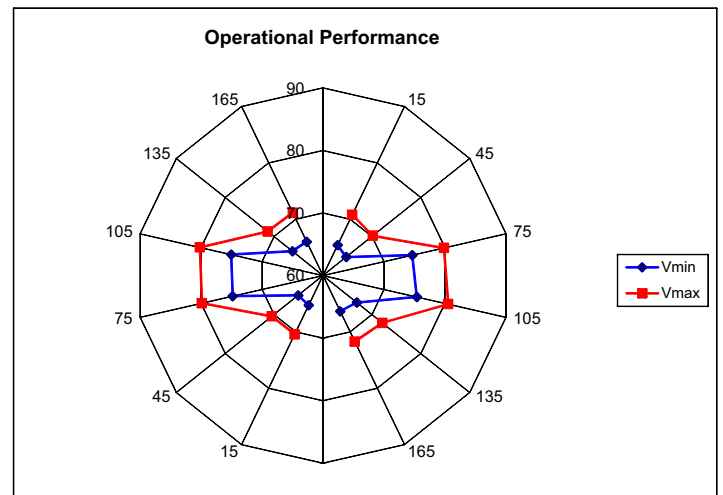

**Tone 11- Dutch Sweep Tone**

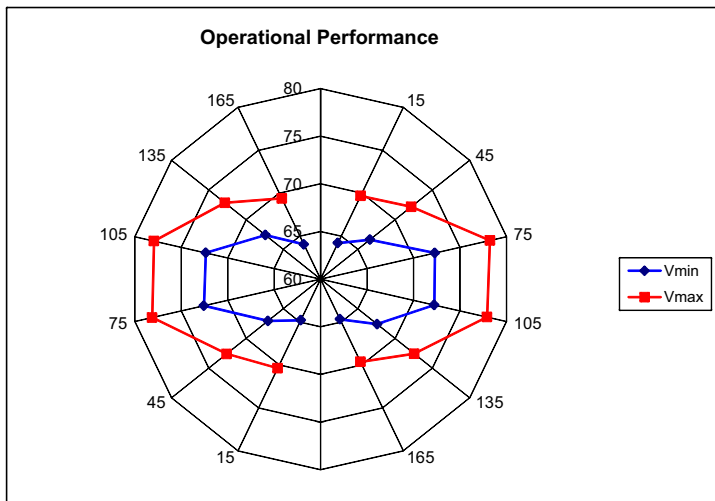

**Tone 25 - German DIN Tone**

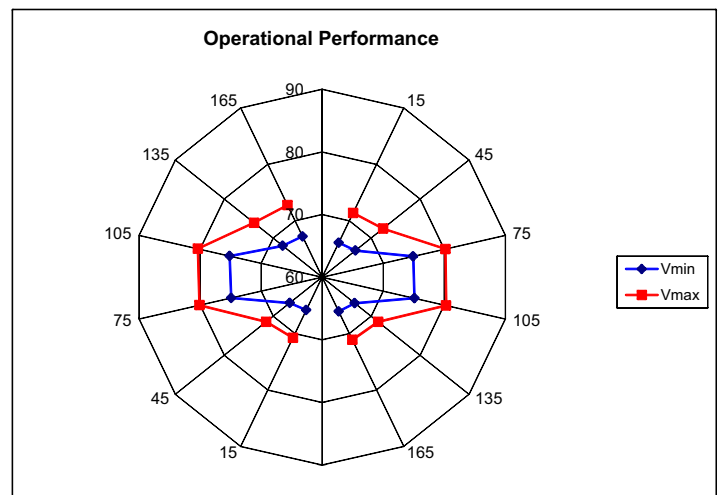

**Tone 27 - French AFNOR Tone**

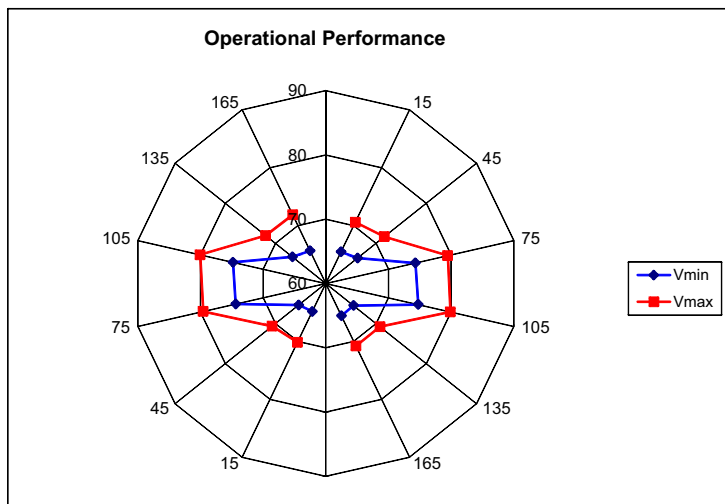

## EN54-3 APPROVED MINIMUM SOUND OUTPUT AT 1 METRE - HIGH VOLUME

**Tone 1 - Cranford Sweep Tone**

Angle	Horizontal Plane dB(A)		Vertical Plane dB(A)	
	Vmin	Vmax	Vmin	Vmax
15°	85.81	90.19	86.027	90.187
45°	86.12	90.44	85.99	90.421
75°	93.95	97.86	93.792	97.68
105°	94.29	98.23	94.073	98.006
135°	86.26	89.97	86.781	90.482
165°	86.86	90.27	87.148	90.716

**Tone 8 - 800Hz Continuous Tone**

Angle	Horizontal Plane dB(A)		Vertical Plane dB(A)	
	Vmin	Vmax	Vmin	Vmax
15°	84.44	88.58	84.557	88.772
45°	84.74	89.05	84.003	88.371
75°	93.65	97.66	93.331	97.523
105°	93.77	97.76	94.094	98.397
135°	84.73	88.76	86.308	89.952
165°	85.14	89.14	85.856	89.834

**Tone 11 - Dutch Sweep Tone**

Angle	Horizontal Plane dB(A)		Vertical Plane dB(A)	
	Vmin	Vmax	Vmin	Vmax
15°	84.1	88.02	84.001	88.009
45°	86.36	90.29	86.608	90.615
75°	92.2	96.55	92.566	96.673
105°	92.13	96.46	92.154	96.288
135°	87.28	91.13	86.304	90.417
165°	83.92	87.66	83.191	87.09

**Tone 25 - German DIN Tone**

Angle	Horizontal Plane dB(A)		Vertical Plane dB(A)	
	Vmin	Vmax	Vmin	Vmax
15°	84.54	89.22	85.44	86.313
45°	85.28	90.34	86.347	90.513
75°	93.73	97.77	93.749	97.762
105°	93.95	97.94	93.867	97.938
135°	87.42	90.63	85.423	89.779
165°	86.62	90.15	84.935	89.147

**Tone 27 - French AFNOR Tone**

Angle	Horizontal Plane dB(A)		Vertical Plane dB(A)	
	Vmin	Vmax	Vmin	Vmax
15°	83.882	87.869	84.065	87.15
45°	84.874	88.892	85.368	88.477
75°	93.03	96.879	92.758	96.602
105°	93.291	97.227	93.179	97.203
135°	85.4	89.357	84.831	89.456
165°	84.776	88.691	84.429	88.592

**Tone 1 - Cranford Sweep Tone**

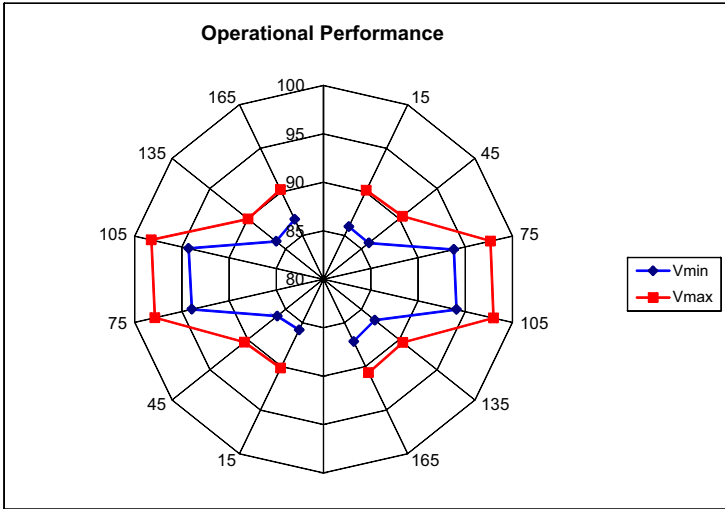

**Tone 8 - 800Hz Continuous Tone**

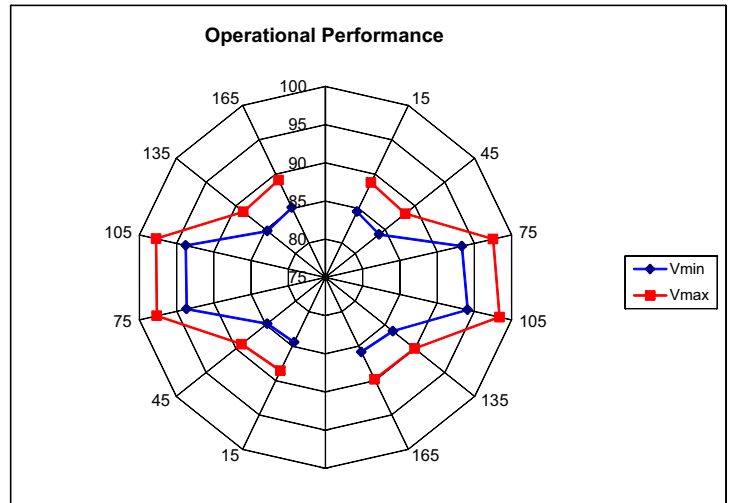

**Tone 11 - Dutch Sweep Tone**

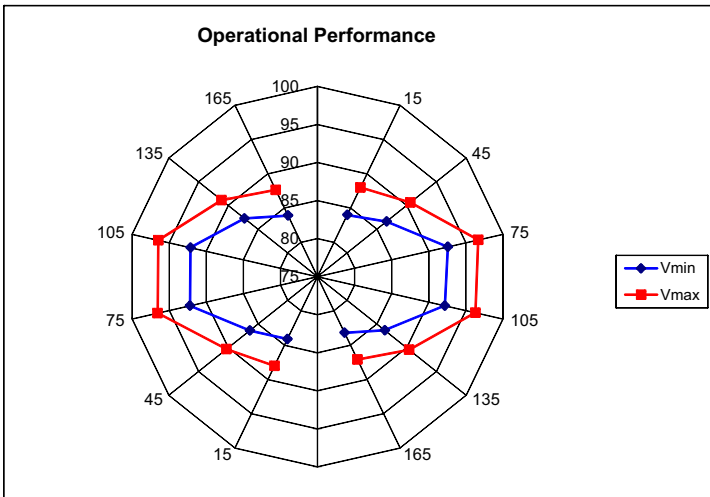

**Tone 25 - German DIN Tone**

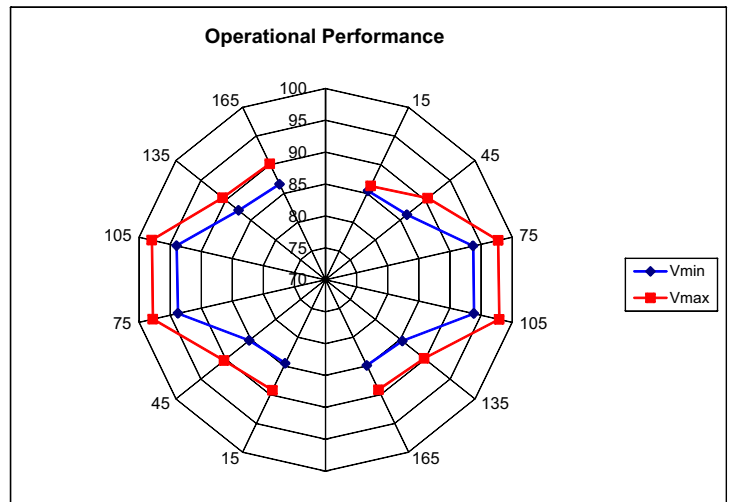

**Tone 27 - French AFNOR Tone**

