



Features

- Available in 450mm and 600mm depths
- 6u, 9u, 12u and 15u height options
- Quick Release, Reversible, Tempered Glass Door
- Superior airflow for equipment cooling
- Top and bottom cable entry plate
- Quick release door and side panels
- 25 minute assembly time

Description

Our range of 450mm and 600mm deep Flat pack Wall Cabinets is the perfect solution for installing data, security and AV equipment.

These cabinets have been designed for speed of assembly and installation.

The wall-cabinets have a removable back panel for mounting on uneven walls and a Quickfit hanging bracket for ease of installation.

With modern functional aesthetics, these cabinets will perform functionally in any application.

All screws and fixings to assemble the cabinet are supplied and they also comes supplied with 20 cage nuts and screws.

Tools required: Philips Screwdrivers and allen keys

Ordering Information

450mm Deep Wall Cabinet	
52-6U450BLK-FLAT	6u Wall Cabinet 450 Deep Black (Flatpack)
52-6U600BLK-FLAT	6u Wall Cabinet 600 Deep Black (Flatpack)
52-9U450BLK-FLAT	9u Wall Cabinet 450 Deep Black (Flatpack)
52-9U600BLK-FLAT	9u Wall Cabinet 600 Deep Black (Flatpack)
52-12U450BLK-FLAT	12u Wall Cabinet 450 Deep Black (Flatpack)
52-12U600BLK-FLAT	12u Wall Cabinet 600 Deep Black (Flatpack)
52-15U450BLK-FLAT	15u Wall Cabinet 450 Deep Black (Flatpack)
52-15U600BLK-FLAT	15u Wall Cabinet 600 Deep Black (Flatpack)

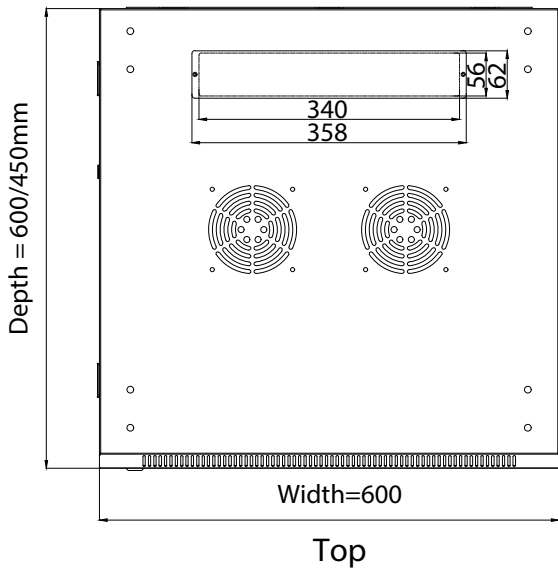

H:
 6U = 370.00 mm
 9U = 503.35 mm
 12U = 636.70 mm
 15U = 770.05 mm
 18U = 903.40 mm

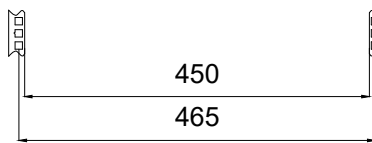
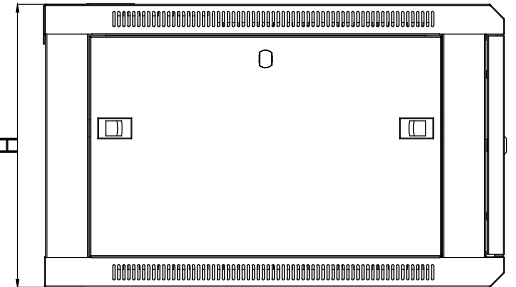
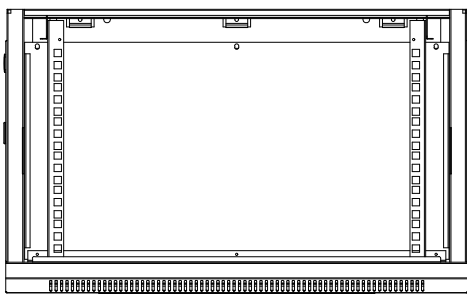
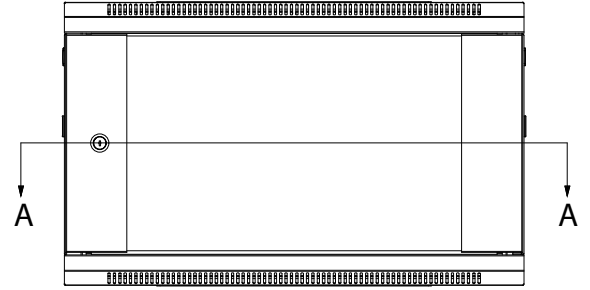
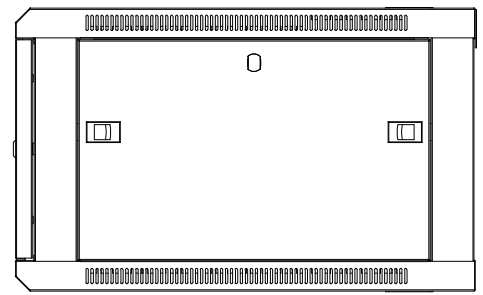



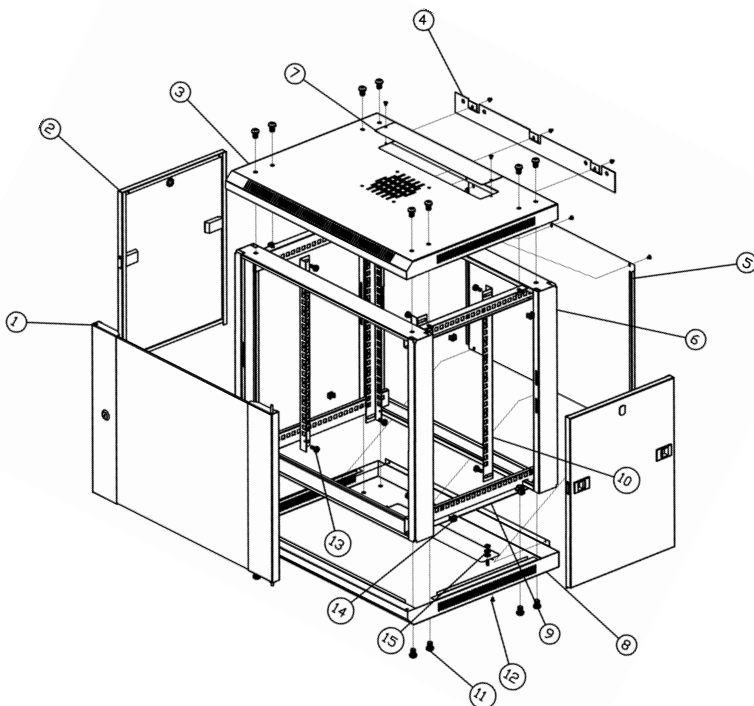

Mounting dimension









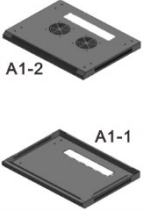

1	Front glass door
2	Side panels
3	Top Cover (with fan vents)
4	Wall mounting bracket
5	Back Panel (optional)
6	Frame (front & rear)
7	Cable entry cover
8	Bottom cover
9	Mounting Angle
10	Mounting Profile
11	M8 x 12 Hex screws
12	M4 x 8 Self-tapping screws
13	M6 x 12 Screws and washers
14	M6 Screws and cage nuts
15	Grounding post

Flat-Packed Wall-Box Assembly Instructions

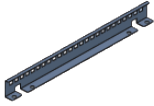





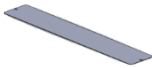



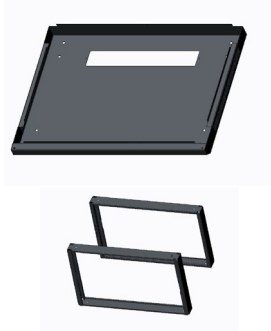

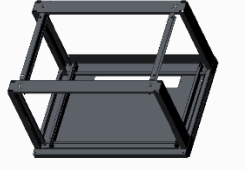
Screw list

	A	B	C	D
Type	Philips head self-tapping screws	Philips head screws & flange nuts	Hex socket cup screws & flange nuts	Philips head screws & cage nuts
				
Screw Spec.	M4 x 8	M6 x 12	M8 x 12	M6 x 12
Quantity (pcs)	10	8	16	20
Usage	Cable entry, rear panel	Mounting rails	Front & rear frames, top & bottom covers	Installation Screw sets for your devices

Parts list

A1	A2	A3	B1	C1
				
Top & bottom cover	Front and rear frame	Side bar	Mounting profile	Side panel
D1	D2	E1	E2	
				
Rear panel	Front door	Small round lock	Cable entry panel	

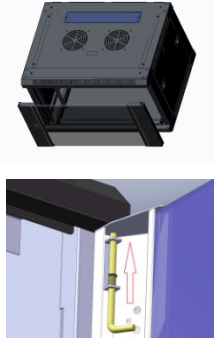
Assembly Instructions

1	2	3	4
			
<p>Bottom cover, front & rear frames</p>	<p>Fix the front & rear frame to the bottom cover using type C screws</p>	<p>Side bar x 4</p>	<p>Install side bars using type C screws onto top & bottom frame</p>
5	6	7	8
			
<p>Top cover</p>	<p>Fix top cover to the front and rear frames using type C screws.</p>	<p>Mounting profile x 4 rails</p>	<p>Install mounting profiles using type B screws</p>
9	10	11	12
 			
<p>Fix top & bottom cable entry covers and rear panel using A type screws</p>	<p>Fix side panel x 2</p>	<p>Join front door with hinges</p>	<p>Finish assembly</p>